

SNAP SIGNAL[®]

IIoT Made Easy



BANNER[®]
more sensors, more solutions

Monitor Your Factory Data in a Snap

Customers use Banner's Snap Signal hardware and software to instantly unlock valuable data from their equipment and increase productivity. This smart-factory portfolio forms an overlay network by capturing signals from existing and new devices, converting them to a unified protocol, and then distributing them to monitoring platforms, such as SCADA systems, the cloud, or a local PLC/HMI for consumption. The solution deploys easily by leveraging available information without disrupting your existing controls. This helps save you money, reduces downtime, and optimizes your operations.

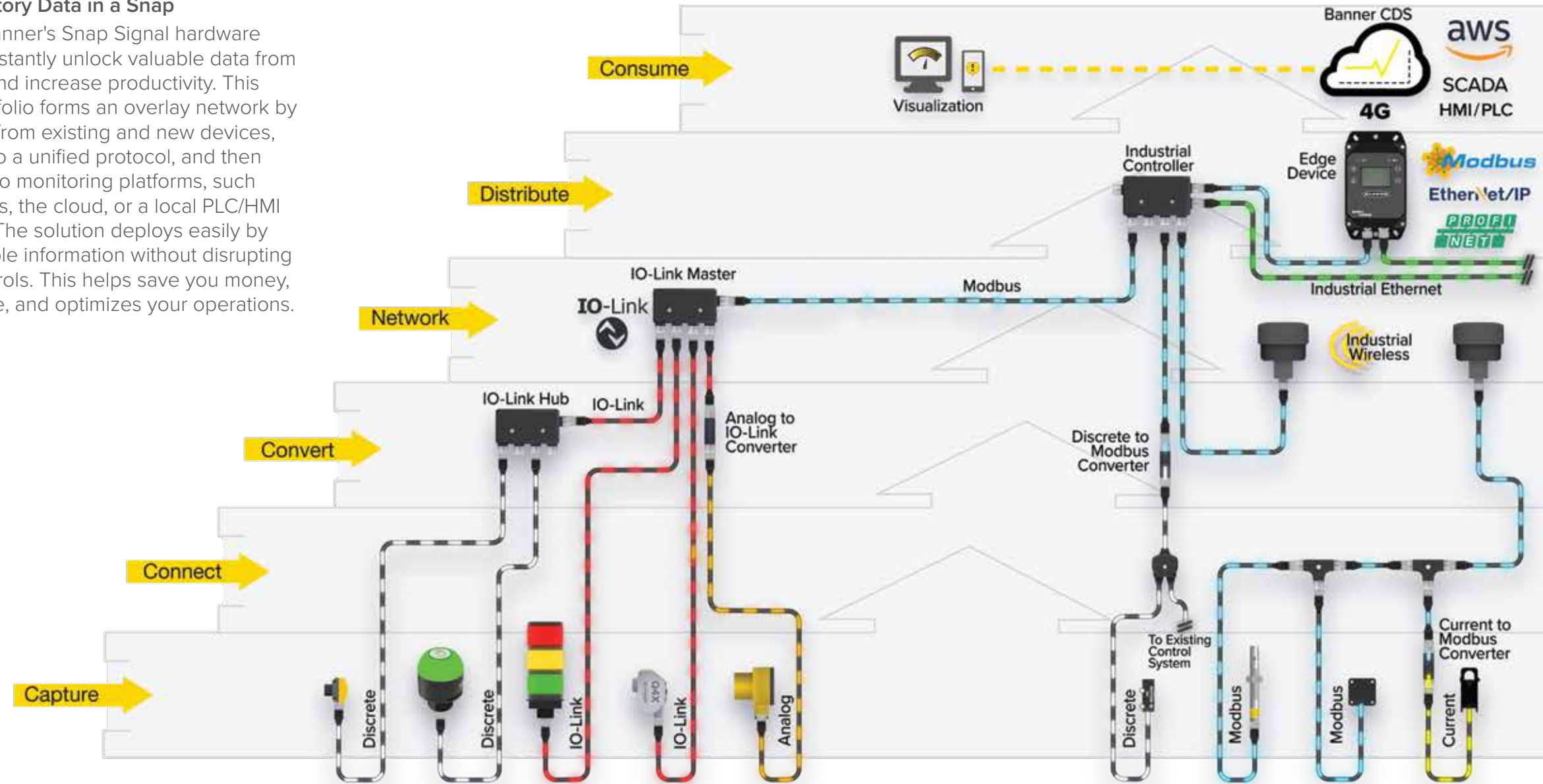

Capture Actionable Data

The devices that outfit automated production lines—sensors, tower lights, motor drives, valves, and other components—transmit electronic signals as part of their basic functionality. For example, whenever a sensor detects an item moving along a conveyor, or activates an indication light, or identifies that a motor is running hot, there is a pulse of activity. By adding a system to monitor these signals, you can unlock a wealth of valuable information.

By monitoring a single sensor, you begin to understand cycle time, throughput, and uptime. If you had multiple machines with identical sensing points, you could monitor each one and compare their performance. Or this data could be used for improving efficiencies, reducing downtime, and lowering costs. It could even be used for predictive equipment maintenance.

It all starts with capturing the data that will be beneficial to your operation. Snap Signal is designed to be brand agnostic, modular, and scalable, so you can capture data from your existing devices (or add new ones), visualize that information, and make insight-driven decisions.



Maximize Throughput and Reduce Downtime by Harnessing Sensor Data from Your Equipment

- Monitor production throughput and performance using existing sensors and Snap Signal converters
- Calculate OEE metrics, such as availability, performance, and quality, locally on the DXMR90 industrial controller
- Send actionable data to the cloud directly from the DXMR90



Provide Real-Time Tank Level Monitoring Data to Efficiently Manage Inventory

- Connect existing ultrasonic or radar tank-level sensors
- Monitor tank volume and make decisions at the sensor level with the DXMR90
- Send actionable tank-level data and alerts to Banner's Cloud Data Services (CDS)

Keep Hydraulic Power Units Running at Peak Performance

- Add Snap Signal converters to sensors measuring any machine condition, such as pressure, current, oil temperature, and vibration
- Send data from hydraulic machinery to the DXMR90 for real-time condition monitoring
- Set alerts locally or in the cloud to respond to potential failures quickly

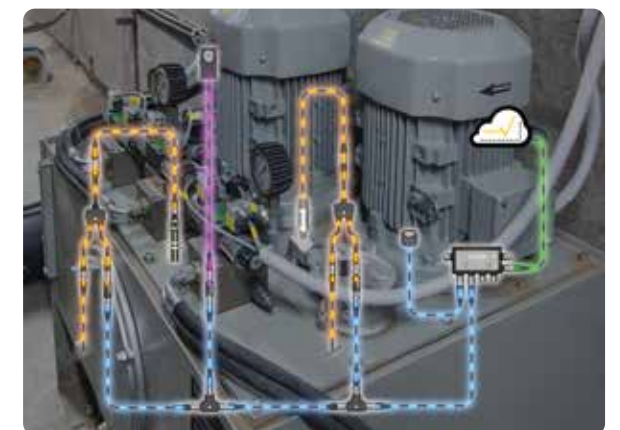

Learn more at snapsignal.bannerengineering.com

Connect Your Devices

Snap Signal products are designed to be part of a plug-and-play solution. Snap Signal incorporates M12 connectors, which are the industry standard for joining devices together. This makes it possible to deliver the benefits of Snap Signal as an "overlay network," which consists of using splitter cables to connect to existing devices.

This overlay network is unique. Nothing is disabled from, or interferes with, the existing control system; instead, the attached monitoring connections simply "listen in" to the signals. The overlay network also speeds up the process of monitoring devices on your machine, because it connects quickly and does not require previous cable runs to be rerouted. Any device that does not already have an M12 connector can be easily converted using field-wirable M12 connectors.



S15A Wiring Adapter

- Adapters reroute wiring to match specific application requirements
- Match outputs to inputs and isolate select signals
- Rugged over-molded design meets IP65, IP67, and IP68 standards
- Simple M12 connection for easy installation wherever needed in the circuit
- Custom options are available

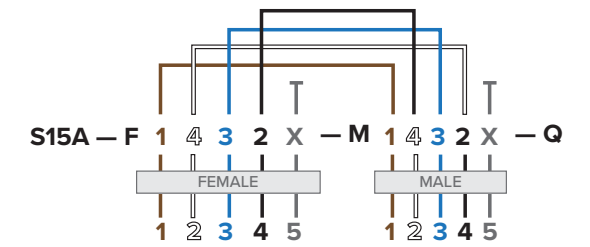
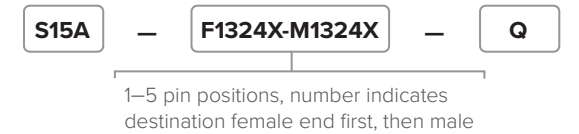

Function Description	Model
Pin 2 goes to Pin 4 in both directions	S15A-F14325-M14325-Q
Female Pin 4 goes to Male Pin 5	S15A-F1235X-M123X4-Q
Female Pin 2 goes to Male Pin 5	S15A-F1534X-M1X342-Q
Pin 1 is open; all others pass through	S15A-FX2345-MX2345-Q
Pin 2 is open; all others pass through	S15A-F1X345-M1X345-Q



S15F In-Line Filter

- Protect devices from electrical noise and transients
- Rugged over-molded design meets IP65, IP67, and IP68 standards
- Simple M12 connection for easy installation wherever needed in the circuit
- Improve signal integrity and reduce troubleshooting time, and install wiring more quickly

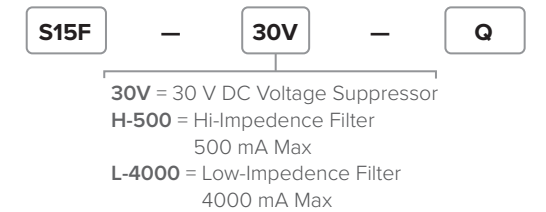
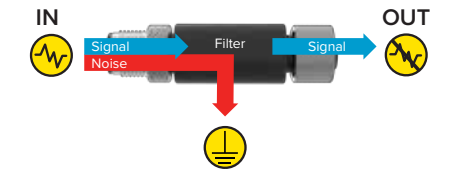

Function Description	Model
Filter; High impedance, rated to 500mA	S15F-H-500-Q
Filter; Low impedance, rated to 4000mA	S15F-L-4000-Q
Suppressor; Rated to 30 V dc	S15F-30V-Q



S15J In-Line Fuse

- Protect devices from over-current
- Rugged over-molded design meets IP65, IP67, and IP68
- Simple M12 connection for easy installation where needed in the circuit
- LEDs provide fuse status to indicate healthy or blown status

Function Description	Model
Fast-blow fuse, 2 A max	S15J-2AFB-Q
Fast-blow fuse, 3 A max	S15J-3AFB-Q

Cable: PVC jacket, PUR (polyurethane) connector body, nickel-plated brass coupling nut

Conductors: 22 AWG or 24 AWG (open shield only) high-flex stranded, gold-plated contacts

Temperature: -40° to +90° C

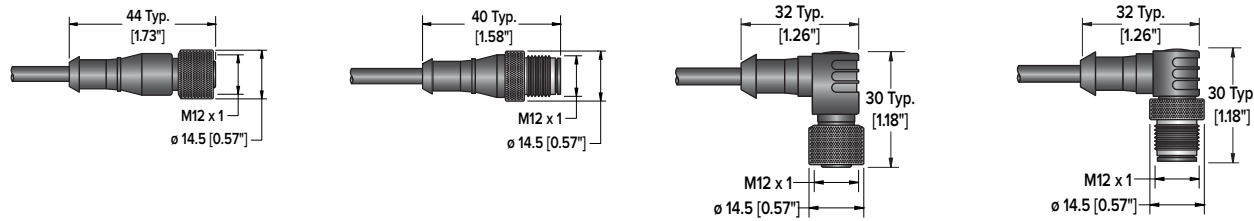

4-Pin M12 Cordsets (Voltage: 250 V DC/AC, Current: 4 A)

	Length	Straight	Right-Angle	Pinout	
4-Pin Female QD to Flying Leads	1 m	MQDC-403	—	 1 = Brown 2 = White 3 = Blue 4 = Black	
	2 m	MQDC-406	MQDC-406RA		
	3 m	MQDC-410	—		
	5 m	MQDC-415	MQDC-415RA		
	9 m	MQDC-430	MQDC-430RA		
	15 m	MQDC-450	MQDC-450RA		
	18 m	MQDC-460	MQDC-460RA		
	21 m	MQDC-470	MQDC-470RA		
30 m	MQDC-4100	MQDC-4100RA	22 AWG	Cable ϕ – 5.2 mm	
4-Pin Male QD to Flying Leads	2 m	MQDMC-406	MQDMC-406RA	 1 = Brown 2 = White 3 = Blue 4 = Black	
	5 m	MQDMC-415	MQDMC-415RA		
	9 m	MQDMC-430	MQDMC-430RA		
				22 AWG	Cable ϕ – 5.2 mm

	Length	Straight/Straight (female/male)	Straight/Right-Angle (female/male)	Pinout	
4-Pin Double-Ended	0.3 m	MQDEC-401SS	MQDEC-401SR	 1 = Brown 2 = White 3 = Blue 4 = Black	
	0.6 m	MQDEC-402SS	—		
	0.9 m	MQDEC-403SS	MQDEC-403SR		
	1.8 m	MQDEC-406SS	MQDEC-406SR		
	3.0 m	MQDEC-410SS	—		
	3.6 m	MQDEC-412SS	MQDEC-412SR		
	4.5 m	MQDEC-415SS	MQDEC-415SR		
	6.1 m	MQDEC-420SS	MQDEC-420SR		
	9.2 m	MQDEC-430SS	MQDEC-430SR		
	15.2 m	MQDEC-450SS	MQDEC-450SR		
				22 AWG	Cable ϕ – 5.2 mm

Note: Not all models are shown. Please contact Banner for other available double-ended styles.

5-Pin M12 Cordsets (Voltage: 60 V DC/AC, Current: 4 A)

	Length	Straight	Right-Angle	Pinout	
5-Pin Female QD to Flying Leads	0.9 m	MQDC1-503	—	 1 = Brown 2 = White 3 = Blue 4 = Black 5 = Gray	
	2 m	MQDC1-506	MQDC1-506RA		
	5 m	MQDC1-515	MQDC1-515RA		
	9 m	MQDC1-530	MQDC1-530RA		
	19 m	MQDC1-560	—		
	30 m	MQDC1-5100	—		
22 AWG				Cable ϕ – 5.6 mm	
5-Pin Male QD to Flying Leads	2 m	MQDMC-506	MQDMC-506RA	 1 = Brown 2 = White 3 = Blue 4 = Black 5 = Gray	
	5 m	MQDMC-515	MQDMC-515RA		
	9 m	MQDMC-530	MQDMC-530RA		
				22 AWG	Cable ϕ – 5.6 mm

	Length	Straight/Straight (female/male)	Straight/Right-Angle	Pinout			
5-Pin Double-Ended	0.3 m	MQDEC-501SS	—	 1 = Brown 2 = White 3 = Blue 4 = Black 5 = Gray			
	1 m	MQDEC-503SS	—				
	2 m	MQDEC-506SS	—				
	5 m	MQDEC-515SS	—				
						22 AWG	Cable ϕ – 5.6 mm

Note: Not all models are shown. Please contact Banner for other available double-ended styles.

M12 Coiled Cordsets

	Length	Straight	Pinout
4-Pin Coiled Cordsets	0.8 to 1.7 m	MQDC-401.7M-PUR-C	 1 = Brown 2 = White 3 = Blue 4 = Black 22 AWG Cable ϕ – 5.2 mm
	1.0 to 2.6 m	MQDC-402.6M-PUR-C	
	1.2 to 3.3 m	MQDC-403.3M-PUR-C	
4-Pin Coiled Double-Ended Cordsets	0.8 to 1.7 m	MQDEC-401.7M-PUR-C	 1 = Brown 2 = White 3 = Blue 4 = Black 22 AWG Cable ϕ – 5.2 mm
	1.0 to 2.6 m	MQDEC-403.3M-PUR-C	

M12 Splitters and Tees



	Models	Cable Lengths		Pinout
		Branches (Female)	Trunk (Male)	
4-Pin	CSB-M1240M1240	No Branch	No Trunk	 1 = Brown 2 = White 3 = Blue 4 = Black
	CSB-M1240M1241	2 x 0.3 m	No Trunk	
	CSB-M1241M1241	2 x 0.3 m	0.3 m	
	CSB-M1243M1243	2 x 1 m	1 m	
	CSB-M1243M1246	2 x 2 m	1 m	
	CSB-M1248M1241	2 x 0.3 m	2.4 m	
	CSB-M12415M1241	2 x 0.3 m	4.6 m	
	CSB-UNT425M1241	2 x 0.3 m	7.6 m Unterminated	

22 AWG Cable ø – 6.0 mm

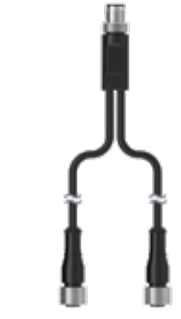

	Models	Cable Lengths		Wiring Diagrams
		Branches (Female)	Trunk (Male)	
4-Pin	S15YB-M124-M124-0.2M	2 x 0.2 m	No Trunk	
	S15YA4-M124-M124-0.2M			
	S15YA24-M124-M124-0.2M			

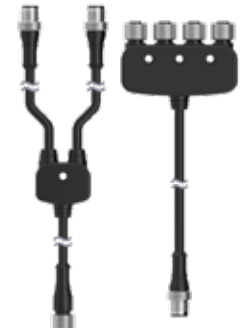

	Models	Cable Lengths		Pinout
		Branches	Trunk	
5-Pin	CSB-M1251FM1251M	2 x 0.3 m (Male)	0.3 m (Female)	 1 = Brown 2 = White 3 = Blue 4 = Black 5 = Gray
	CSB4-M1251M1250	4 x No Branch (Female)	0.3 m (Male)	

22 AWG Cable ø – 5.6 mm



	Models	Branches	Trunk	Pinout
	CSB-M1250M1250-A	No Branch	No Trunk	

M12 Molded Junction Blocks



	Models	Cable Lengths		Pinout
		Branches (Female)	Trunk (Male)	
5-Pin	R50-4M125-M125Q-P	4 x No Branch	No Trunk	 1 = Brown 2 = White 3 = Blue 4 = Black 5 = Gray
	R95-8M125-M125Q-P	8 x No Branch	No Trunk	

M12 Field Wireables



	Male/Female	Straight	Pinout
	Female	FIC-M12F4	
5-Pin M12 Field Wireable	Male	FIC-M12M5	 1 = Brown 2 = White 3 = Blue 4 = Black 5 = Gray
	Female	FIC-M12F5	

Ethernet Cordsets

	Length	Straight	Pinout
	5 m	STP-M12D-415	
	9 m	STP-M12D-430	

2 x 24 Pair AWG Cable ø – 6.2 mm UTP Stranded

Accessories



LMBM12MAG
Attaches to M12 cordset end (magnetic)



LMBM12SP
Attaches to M12 cordset end



ACC-CAP M12-10
Protective end cap



LMBS15MAG
Attaches to S15C.. (magnetic)



LMBS15SP
Attaches to S15C..

Convert to a Unified Protocol

After the physical connections are made to the devices on your machine or automation system, we need to get everything speaking the same language. Some devices might send discrete PNP or NPN signals, others might use analog 0–10 V DC signals, and you might plan to add other types of devices in the future, such as current transducers. All of these signals need to be quickly and easily converted to a unified protocol. This enables you to build a serial network.

Most Snap Signal converters are only the size of a single AA battery, and they begin converting signals as soon as they are installed.



S15C Converter

Break free from protocol limitations with S15C in-line converters. S15C converters take various types of signals such as discrete, analog, and others and convert these signals to smart protocols like IO-Link or Modbus. This makes it easy to incorporate existing legacy sensors into standard protocols to enable process monitoring. They are designed to connect directly to a sensor, indicator, or other device and begin operating immediately, fitting seamlessly into your factory applications.

- Allows previously incompatible devices to be connected to a smart system
- Compact form factor
- Rugged over-molded design meets IP65, IP67, and IP68 standards
- Simple M12 connection for easy installation wherever needed in the circuit

S15C Converter

Easily converts signals like 4–20 mA analog to IO-Link without any setup required

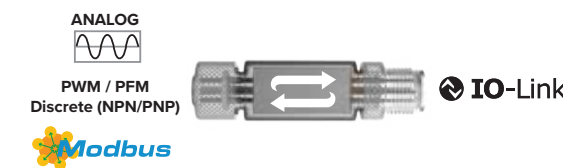

- I = 4–20 mA
- U = 0–10 V DC
- B21 = Discrete Input/Output
- MGN = Modbus
- MGP = Modbus GPS
- MVT = Modbus V/T Sensor
- MEZ = EZ-ARRAY
- MTH = Modbus T/H Sensor
- MUL = Modbus Ultrasonic Sensor

S15C Converter

Easily converts signals like discrete, analog, and more to Modbus which makes it easy to monitor and send data to the cloud

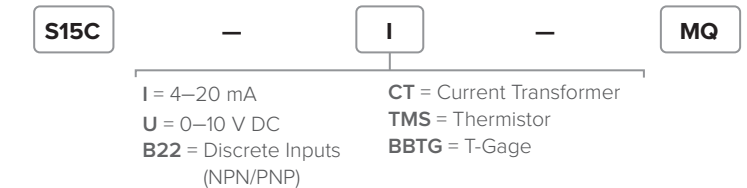
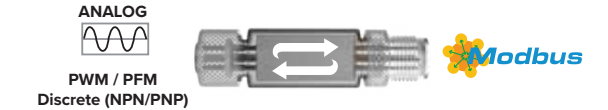

- I = 4–20 mA
- U = 0–10 V DC
- B22 = Discrete Inputs (NPN/PNP)
- CT = Current Transformer
- TMS = Thermistor
- BBTG = T-Gage

S15CM Converter

Compact converter that connects to a Modbus® device and outputs the value as a pulsed signal, either PFM or PWM



- PP = PFM/PWM output
- M = Modbus



R45C IO-Link to Analog Out Converter

- Compact analog to IO-Link device converter that outputs an analog value, voltage or current, as presented by the IO-Link Master
- Rugged over-molded design meets IP65, IP67, and IP68
- Connects directly to a sensor or anywhere in-line for ease of use

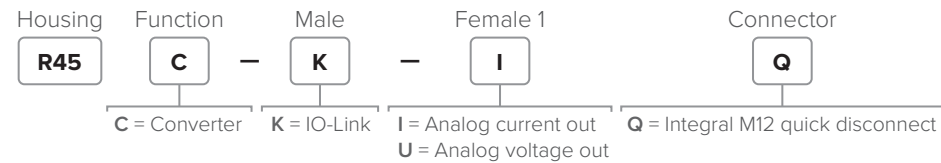

R45C IO-Link to Analog In or Out Converter

- Compact analog to IO-Link device converter that outputs an analog value, voltage or current, as presented by the IO-Link Master
- The converter also connects to an analog source, voltage or current, and outputs the value to the IO-Link Master
- Rugged over-molded design meets IP65, IP67, and IP68
- Connects directly to a sensor or anywhere in-line for ease of use

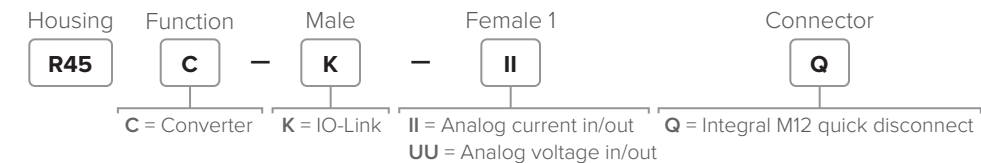

R45C IO-Link to Dual Analog Input-Output Converter

- Compact IO-Link device to analog converter that outputs an analog value, voltage or current, as presented by the IO-Link master
- The converter also connects to an analog source, voltage or current, and outputs the value to the IO-Link master and as a representative PFM output
- Rugged over-molded design meets IP65, IP67, and IP68
- Connects directly to a sensor or anywhere in-line for ease of use

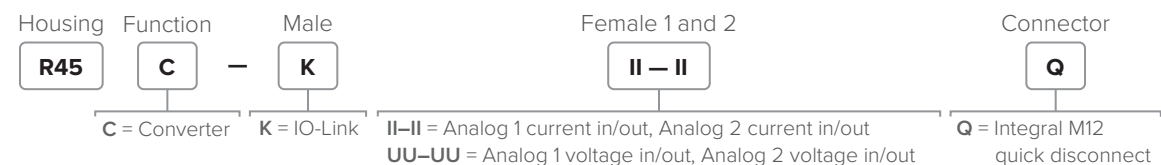

R90C and R95C IO-Link Hubs

The R90C and R95C IO-Link Hubs connect two discrete signals to each of the unique ports, providing access to monitoring and configuring those ports with an IO-Link Master. Host mirroring is available where a selected port input/output discrete signal can be routed to Pin 2 (male) on the PLC/Host connection.

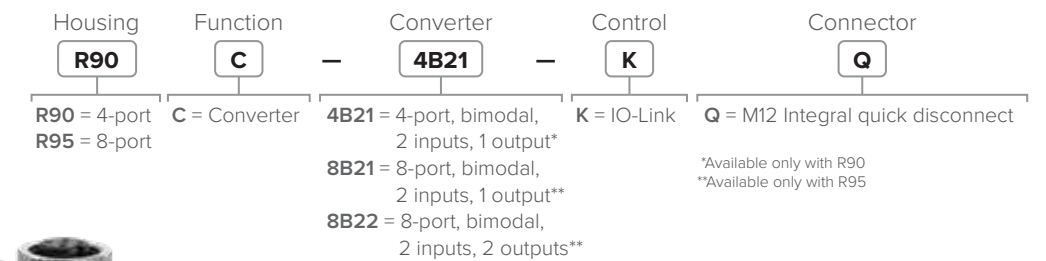

R95C Discrete Bimodal to Modbus Hub

The R95C discrete bimodal to Modbus Hub connects two discrete channels to each of the eight unique ports, providing access to monitoring and configuring those ports via Modbus registers. Host mirroring is available where a selected port input/output discrete signal can be routed to Pin 5 (male) on the PLC/Host connection.

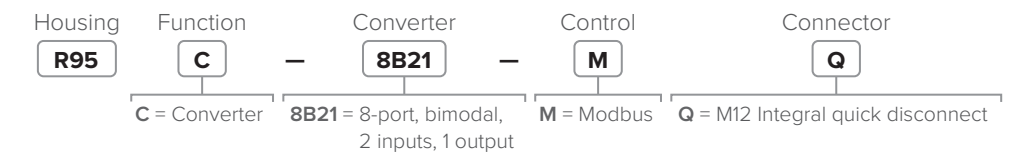

Accessories



SMBR90S
Mounting Bracket
(use multiples to stack)

LMBM12MAG
Attaches to
M12 cordset end
(magnetic)

LMBM12SP
Attaches to
M12 cordset end

ACC-CAP M12-10
Protective
end cap

LMBS15MAG
Attaches to
S15C
(magnetic)

LMBS15SP
Attaches to
S15C

CHALLENGE

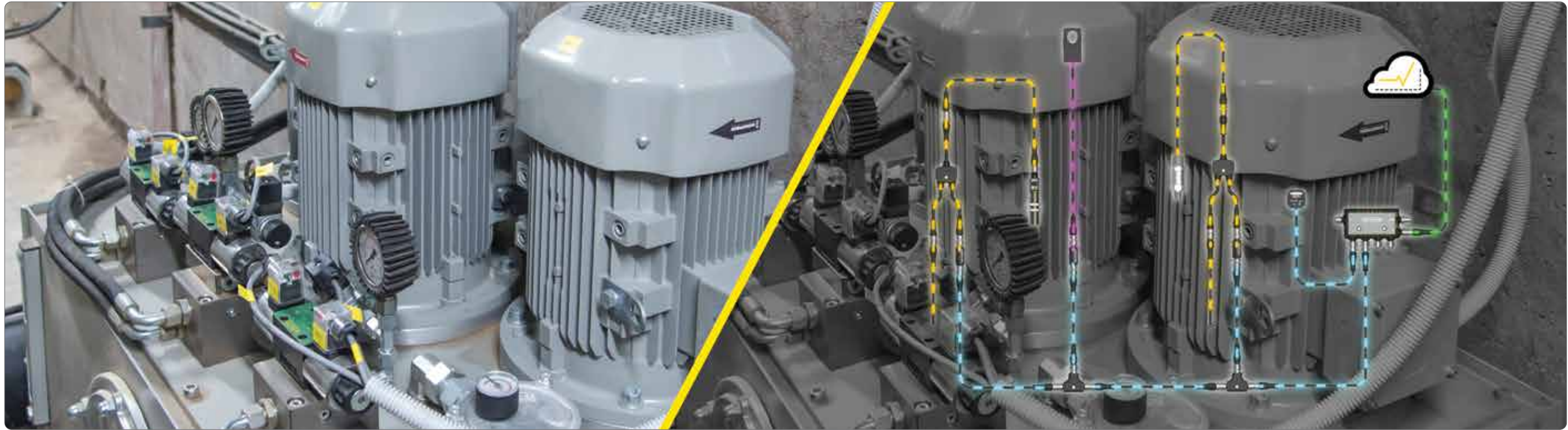

SOLUTION

Keep Hydraulic Power Units at Peak Performance

Challenge

Monitor the pressure, current, oil temperature, and motor vibration/temperature of hydraulic power units and other hydraulic machinery.

Solution

Condition monitoring makes it possible to ensure that all equipment is working at optimal efficiency, and to detect and address potential maintenance issues before they lead to costly production downtime.

The Snap Signal system is designed to be a brand-agnostic, overlay-architecture technology, meaning that there's no need to replace existing hydraulic systems or even older sensors. Snap Signal converters, adapters, or filters can be installed to branch off from existing sensors and send Modbus signals to a Banner DXMR90 Industrial Controller device. This controller combines multiple Modbus signals—potentially from an entire production environment—into a single data stream that can be processed in cloud networks, including Banner's own Cloud Data Services (CDS). Then, users can monitor equipment performance data from anywhere with online visualization tools, and receive 24/7 notifications about any hydraulic component operating below customizable thresholds. Additionally, monitored machine health can be displayed on site using connected indicators, such as Banner tower lights.



S15C Converter

The S15C converter takes various types of signals including discrete, analog, and RTD, transforming them to smart protocols like IO-Link or Modbus.



R45C Converter

The R45C compact in-line converter enables communication between IO-Link devices and equipment that only responds to analog signals.



R90C Hub

The R90C Hub converts and consolidates discrete signals from legacy devices into an IO-Link data stream compatible with other devices including Banner's new IO-Link Master.

Build Your Network

With signals now on unified protocols, it is time to build networks of devices. IO-Link devices and anything that was translated to IO-Link using Snap Signal converters should be connected to an IO-Link Master. Multiple IO-Link Masters can be used, depending on the size and complexity of the system.

The network stage of the Snap Signal process also supports serial protocols and wireless cable replacement products such as the R70 Serial Data Radio. These radios excel in scenarios where running long lengths of cable is not practical or economical.

IO-Link Masters and wireless radios can send collected signals from your entire production system to a device that interprets Modbus data, such as the Banner DXMR90 Industrial Controller.



R45C IO-Link Master Modbus Converter

- Connects two IO-Link devices and provides access via Modbus RTU interface
- Rugged design; easy installation with no assembly or individual wiring required
- 5-pin M12 male quick disconnect connector
- Two 4-pin M12 female quick disconnect connectors
- Built-in indication for two IO-Link Master ports
- Built-in indication for Modbus RTU connection status
- Rugged over-molded design meets IP65, IP67, and IP68



R90C IO-Link Master Modbus Converter

The R90C 4-Port IO-Link Master connects to four IO-Link devices and provides access to IO-Link data and functionality via a Modbus RTU connection. Modbus registers allow for access to both IO-Link devices and their functions:

- Process Data In
- Process Data Out
- Connected device information
- ISDU data
- Discrete I/O configuration
- IO-Link events
- Data storage
- SIO mode

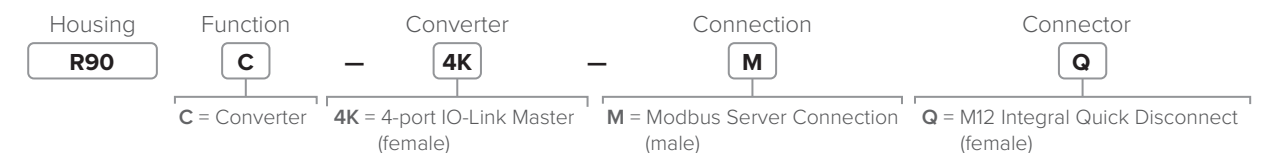



R70 Data Radio

R70 Serial Data Radios are compact, industrial, low-power wireless communications devices used to extend the range of serial communications networks. R70 Ethernet Data Radios are wireless industrial communication devices used to create point-to-multipoint configurations of wireless Ethernet networks.

- Star or tree network topology configuration
- DIP switches select operational modes
- Frequency Hopping Spread Spectrum (FHSS) technology ensures reliable data delivery
- Self-healing, auto-routing radio frequency network with multiple hops to extend the network's range

Model	Communication Type	Frequency	Transmit Power
R70SR9MQ	Serial	900 MHz ISM Band	1 Watt
R70SR2MQ		2.4 GHz ISM Band	65 mW (100 mW EIRP)
R70ER9MQ	Ethernet	900 MHz ISM Band	500 mW
R70ER2MQ		2.4 GHz ISM Band	65 mW (100 mW EIRP)

Tees



	Models	Cable Lengths		Pinout
		Branches (Female)	Trunk (Male)	
5-Pin	CSB-M1250M1250-T	No Branch	No Trunk	<p>Female</p> <p>1 = Brown 2 = White 3 = Blue 4 = Black 5 = Gray</p> <p>Male</p>
	CSB-M1250M1250-A	No Branch	No Trunk	

Accessories



LMB30LP
Mounting Bracket



PSW-24-1
Power Supply



SPS30*
In-Line
AC/DC Converter

*Contact Banner for model numbers

Combine Wired and Wireless Technology for Condition Monitoring

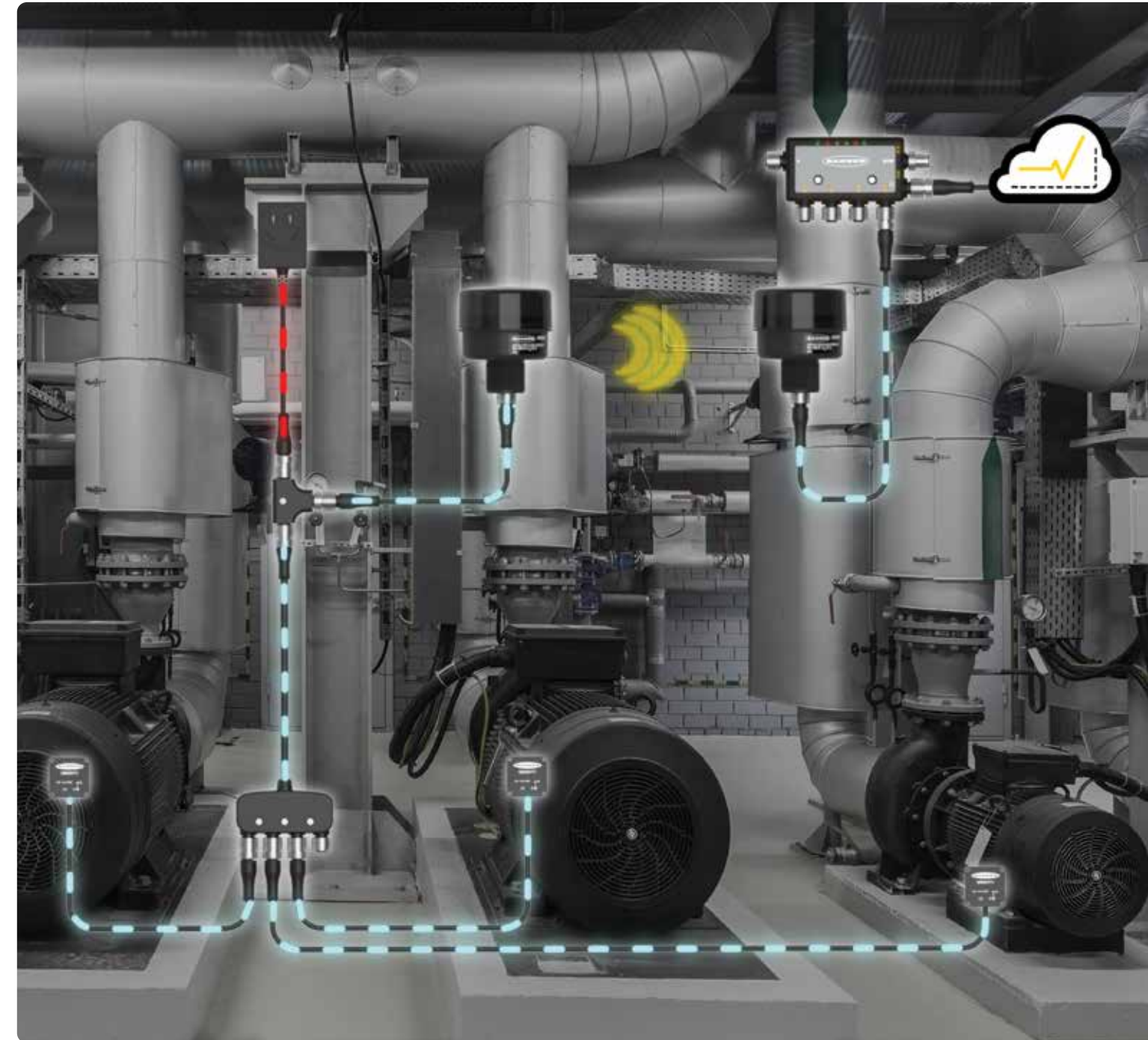

CHALLENGE



SOLUTION

Monitor Tank Level Remotely

Challenge

Provide real-time tank level monitoring data to efficiently manage inventory.

Solution

Tap into existing devices like sensors and lights, or add new ones. Snap Signal products connect sensors of all signal types to bring tank level data onto your industrial network or to the cloud. Configure and deploy with plug-and-play converters and cables. Quickly send data to the cloud with our IoT edge gateways. Banner's cloud provides visualizations and storage.

To monitor existing tank level sensors, you can add a tee or splitter cable to harvest discrete or analog signals that are already installed on this equipment. This allows you to monitor these sensors without disrupting the existing control system. If you need to add the ability to measure level, temperature, and humidity, simply add in the corresponding sensors from Banner Engineering. Snap Signal Converters are used to convert each of these signals to a smart serial protocol so they can all communicate on a common network. Our DXMR90 Industrial Controller is added to collect the information in one place and send it wherever you need it; options include a SCADA system, PLC, or the cloud. If you do not have a cloud platform, check out Banner's Cloud Data Services (CDS), which is a turn-key platform for monitoring all your assets in one place and sending notifications when alarms occur.



R90C IO-Link Master

The R90C IO-Link Master collects signals from IO-Link devices to a Snap Signal IIoT system, or other control systems on the market, through four dedicated IO-Link ports.



R45C IO-Link Master

The R45C IO-Link Master collects signals from IO-Link devices to a Snap Signal IIoT system, or other control systems on the market through two dedicated IO-Link ports.



R70SR Serial Data Radio

The R70SR MultiHop Serial Data Radio extends the range of serial communication networks.

Distribute Your Data

At this stage, the unified protocols are brought together so all the collected signal data from the entire system can be sent to a cloud platform, PLC, HMI, or SCADA. Banner's central control units for Snap Signal data distribution are the DXMR90 and DXMR110 industrial controllers, which feature a D-Code Ethernet port to transmit collected data. It is also possible to connect the controller to a DXM1200 device, which uses a cellular modem to transmit data wirelessly.



DXMR90

DXMR90 controllers are a central component of Banner's Snap Signal system for device monitoring. The industrial controllers house a processor that receives signals from sensors and other connected devices through four dedicated Modbus or IO-Link ports. As a centralized hub, the DXMR90 combines all these signals into one unified stream of insightful data which can be exported via industrial Ethernet protocols.



Ethernet Connection	Master Connections	Other Connections	Models
One female M12 D-Code Ethernet connector	Four female M12 connections for Modbus Four female M12 connections for IO-Link	One male M12 (Port 0) for incoming power and Modbus RS-485, one female M12 for daisy chaining Port 0 signals	DXMR90-X1 DXMR90-4K



DXMR110-8K IO-Link Master

- Local control or connectivity with automation protocols, including EtherNet/IP, Modbus/TCP, and PROFINET
- Logic processing and problem-solving capable of deploying solutions to process and control data from multiple devices
- IP67 housing simplifies installation in any location by eliminating the need for a control cabinet
- Consolidate cable runs to minimize cabling and associated weight, especially in weight-critical applications such as robotics
- Flexible and customizable—expanded internal logic controller with action rules and ScriptBasic programming

Ethernet Connection	IO-Link Master Connections	Other Connections	Models
Two female M12 D-Code Ethernet connectors for daisy chaining and communication to a higher-level control system	Eight female M12 connections for IO-Link	One male M12 for incoming power, one female M12 for daisy chaining power	DXMR110-8K

Accessories

On-board programming and scripting—
MicroPython, ScriptBasic

Industrial Ethernet—
EtherNet/IP, PROFINET,
Modbus/TCP

Logic and math operations

Serial communications

Cloud connectivity—
Banner CDS,
AWS IoT Core

SMBR90S
Mounting Bracket
(use multiples to stack)

SMBR90RA
Mounting Bracket

SMBR90RADIN
DIN Rail
Mounting Bracket

SMBR90RAMAG
Magnetic
Mounting Bracket

PSW-24-1
Power Supply

STP-M12D-406
Ethernet Cordset

CHALLENGE



SOLUTION

Know When to Add Raw Materials to Increase Machine Uptime

Challenge

Your machines need a constant supply of materials to keep production going. Knowing when they're running low is critical.

Solution

Let your machines tell you when they're low on materials. Snap Signal provides this data and makes it available for viewing anywhere it's needed.

Snap Signal lets you keep your current communications network in place. Simply tee into existing analog sensors that measure roll diameter. The sensor data is converted to a unified serial protocol via Snap Signal converters and sent to a DXMR90 Industrial Controller, which can bring this valuable data to Banner Cloud Data Services (CDS) via an Ethernet connection. The information may be visualized anywhere in the world on a dashboard, and call-for-parts messages can be sent automatically to people in the plant via SMS and email. At the machine level, an LED light, like the Banner WLS15 Pro, can also be used to indicate material level.



DXMR90 Industrial Controller

The DXMR90 industrial controller works with a wide range of serial devices. Actionable data is sent to the cloud directly from the DXMR90. Alerts can be set locally or in the cloud to respond to potential failures quickly.

Consume Data to Optimize Productivity

The data gathered from the system needs to be displayed so that machine operators, maintenance staff, and plant managers can make data-driven decisions. The data may be consumed via HMIs, PLCs, SCADA, or cloud platforms including Banner's Cloud Data Services (CDS), offering customizable dashboards for simultaneous and comprehensive online monitoring of devices in Snap Signal systems.

Ultimately, the goal of Snap Signal is to make data available to the people who need it, so that they can make informed decisions about improving processes or troubleshooting problems, thereby improving production throughput, quality, and uptime.

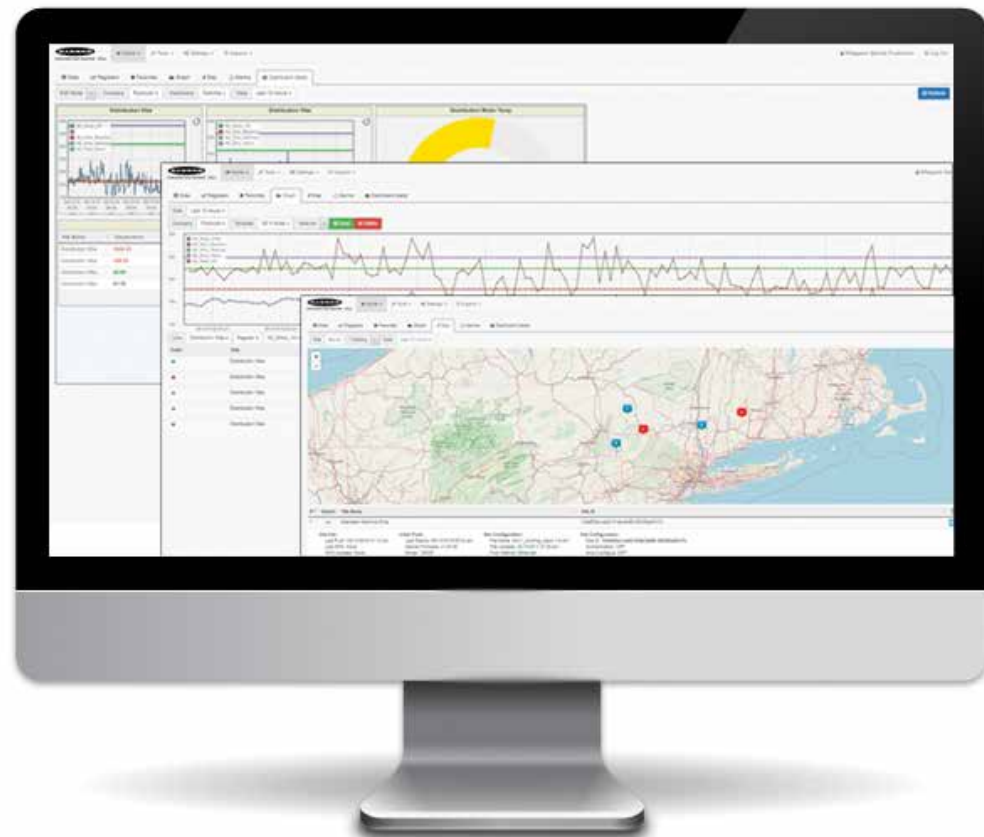

Monitor Your Equipment from Anywhere

The Cloud Data Services software is a web-based platform that allows users to access, store, protect, and export critical data collected by Banner Snap Signal solutions. The software complements the Snap Signal portfolio and provides customers with complete end-to-end IIoT solutions to solve the Industrial market's most pressing problems.

Banner CDS

- The CDS platform is more than a dashboard. With analytics and visualization tools, the software delivers actionable insights that allow you to solve real challenges on the factory floor.
- You can remotely access data anytime and anywhere using an internet-connected device. In addition, you can define parameters to control when to receive notifications via email or SMS message. On-demand visibility and real-time alerts allow you to remotely monitor and diagnose systems quickly, saving time and costs.
- Predictive maintenance is a key capability of Banner's IIoT solutions. The software platform helps you use device data to predict machine maintenance requirements, which reduces unplanned downtime, increases mean time between failure (MTBF), and reduces maintenance costs.
- Data transmissions from your controller are secured via several layers of protection including a proprietary communication protocol and generic data transfer. In addition, data transmissions from the controller to the cloud are securely encrypted.

HMI, SCADA, PLC, or Other Monitoring Platforms

- Snap Signal's unique open architecture allows you to send data where you need it.
- The DXMR90 supports EtherNet/IP®, Modbus/TCP, PROFINET, and Modbus RTU so that data can be interfaced with virtually any industrial system.
- The DXMR90 also supports Internet protocols including MQTT, RESTful, and APIs.



Visit bannercds.com for more information

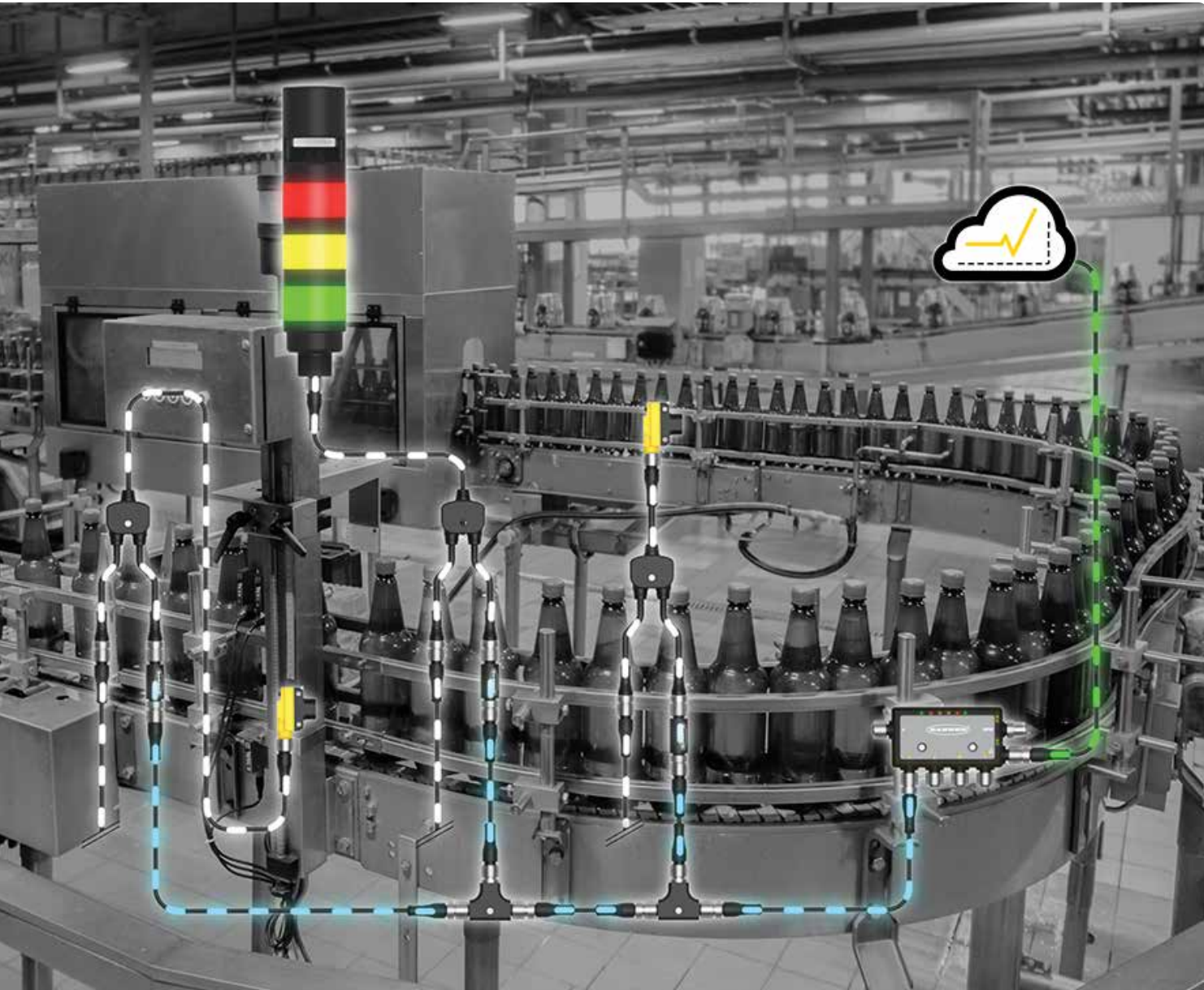

Monitor Your Conveyor System Optimally and Set Alerts in Banner's Cloud Data Services (CDS)

- Identify and correct the source of reduced output in one or multiple production lines with Snap Signal
- Use existing legacy sensors that are already installed to offer valuable insights on process states and error conditions, without disturbing the existing controls system
- Monitor machine performance and help optimize throughput via sensor data sent to Banner CDS

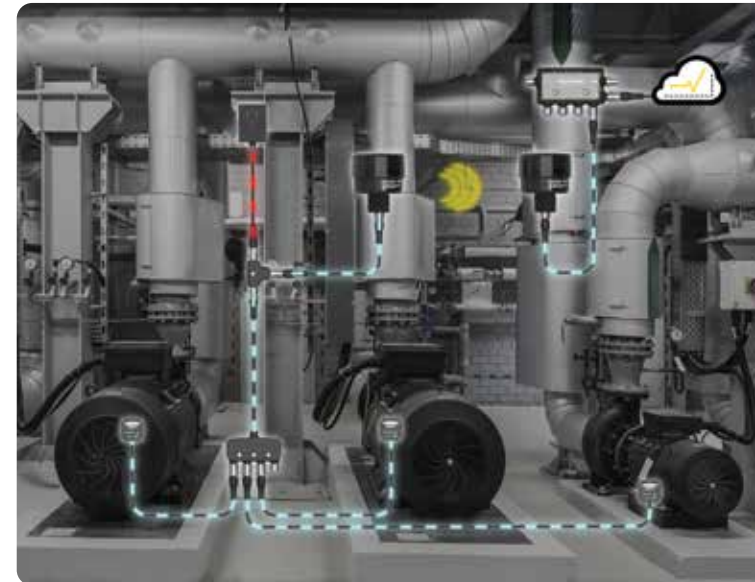

Flexibly Combine Wired and Wireless Technology for Condition Monitoring

- Deploy R70 Serial Radios to send vibration data of machines across your factory to the DXMR90
- Monitor vibration to detect potential failures before downtime occurs
- Send actionable vibration data and alerts to Banner CDS
- Data can also be sent directly to a PLC or SCADA via Modbus TCP, EtherNet/IP, and PROFINET

Monitor Vibration, Tank Level, and Temperature of Existing Equipment

- Add Snap Signal converters and sensors that can measure machine conditions, such as vibration, tank level, and temperature
- Send data to the DXMR90 for real-time condition monitoring
- Set alerts locally or in the cloud to respond to potential failures quickly and keep your equipment running

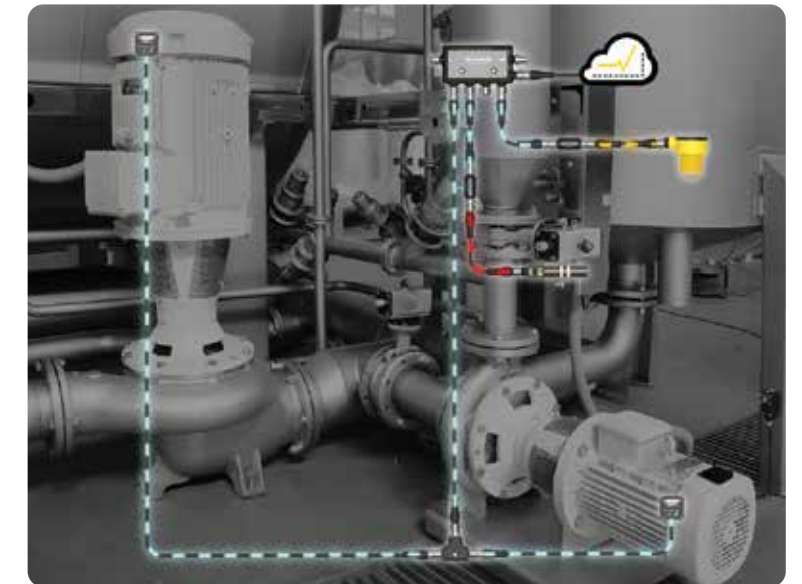

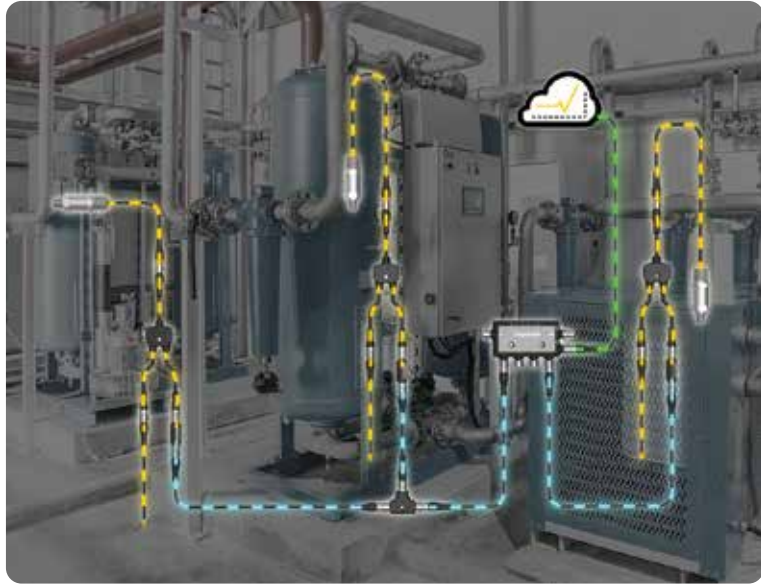

Tap into Pressure Sensor Data for Immediate Insights

- Monitor system pressure at various locations in real-time
- Use active monitoring to quickly identify potential failures or leaks
- Combine incoming pressure sensor information for a comprehensive data stream to the cloud
- Data can also be sent directly to a PLC or SCADA via Modbus TCP, EtherNet/IP, and PROFINET

Monitor System Temperature and Set Alerts in Banner's Cloud Data Services (CDS)

- Bring legacy sensor signals to the cloud for better insights about your machine's health
- Monitor surface temperature to detect overheating parts and collect sensor data via a network of cordsets and the DMXR90 controller
- Create an overlay architecture with easy to implement splitters and M12 cordsets
- Send data to the cloud for consumption, data dashboarding, and setting up email and text alerts

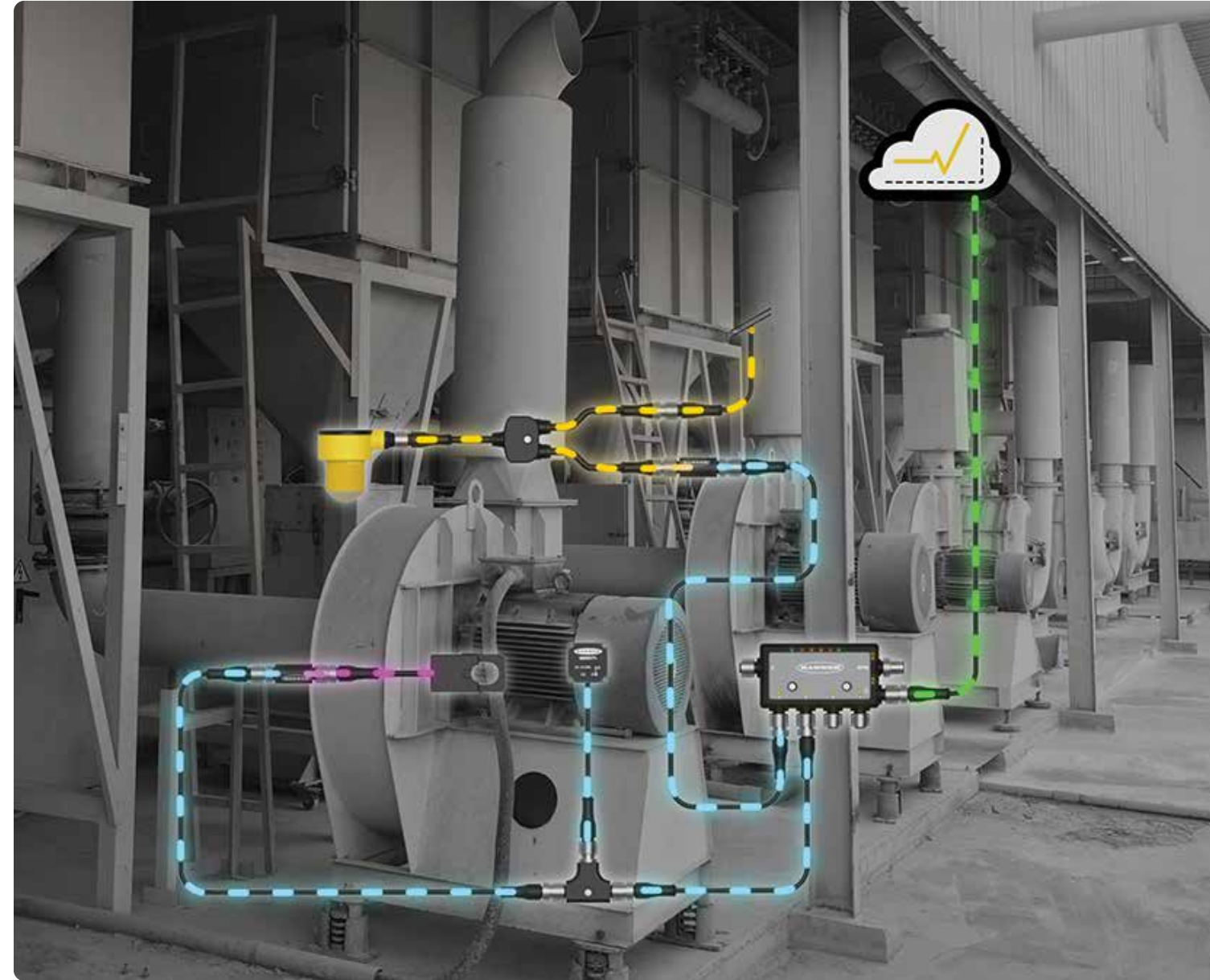

Condition Monitoring of Dust Collection System

- Snap Signal converters provide monitoring data so users can spot small performance changes
- Problems that can be fixed early and fully with predictive maintenance
- Snap Signal converters offer easy, quick-connect setup at all key system points, monitoring vibration and temperature, boiler temperatures, level, and differential pressure
- Start with key equipment with one area or monitor your whole facility with ease and speed

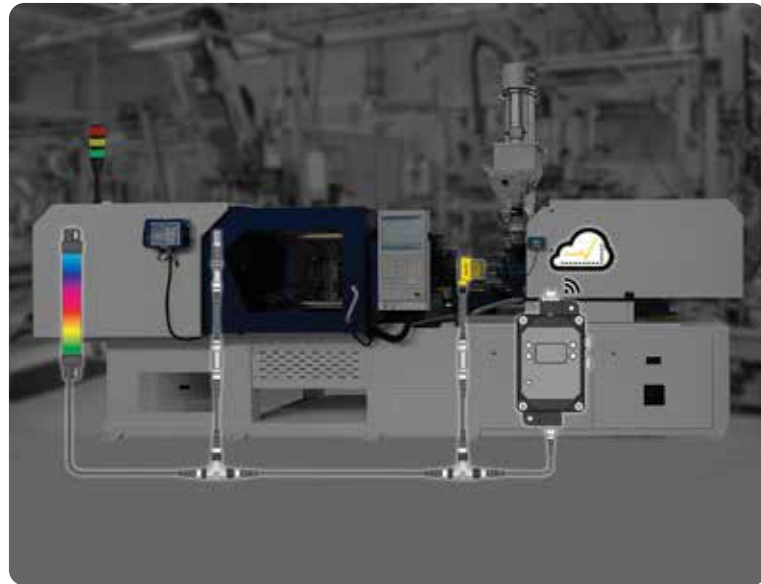

Increase Productivity on an Injection Molding Machine

- Manage your process better and improve productivity and quality
- Snap Signal products interface with existing level sensors and temperature/humidity probes
- To monitor existing sensors and lights, you can add a tee or splitter cable to harvest discrete or analog signals that are already installed without disrupting the existing control system
- Convert each of these signals to a smart serial protocol so they can all communicate on a common network



Monitor Leaks and Receive Real-Time Alerts

- Help personnel respond quickly to reduce downtime
- Banner's fiber optic sensors and amplifiers can work together to easily detect leaks
- An industrial controller can send critical information about the leak to a cloud service
- Instantly send alerts via text or email to personnel who can immediately take corrective action
- Send actionable data and alerts to Banner's Cloud Data Services (CDS)
- Data can also be sent directly to a PLC or SCADA via Modbus TCP, EtherNet/IP, and PROFINET

Measure Throughput and OEE on a Case Sealer

- Collect data from your existing sensors.
- To monitor existing sensors and lights, add a tee or splitter cable to harvest discrete signals that are already installed without disrupting the existing control system
- Convert each of these signals to a serial protocol so they can all communicate on a common network
- Collect the information in one place and send it wherever you need it; options include a SCADA system, PLC, or the cloud

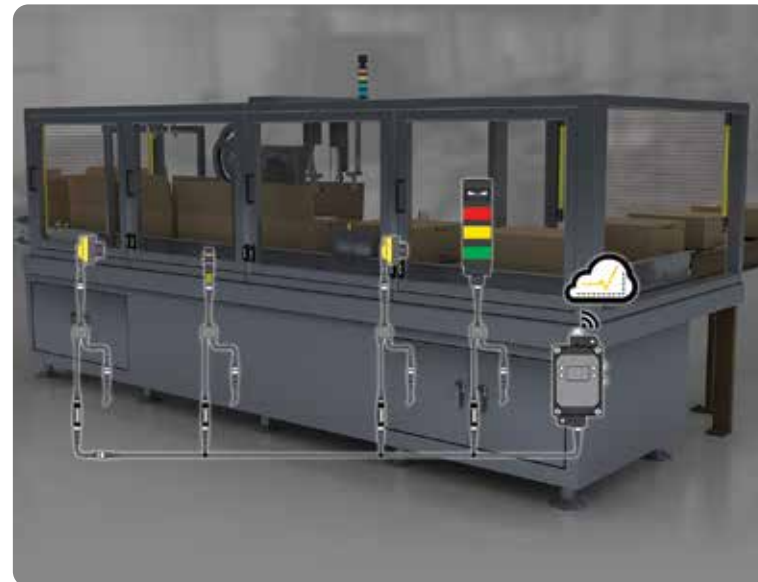

Bring in IO-Link Sensor Data for Tank Level Applications Wirelessly

- Banner's IO-Link Masters allow you to bring back IO-Link sensor data wirelessly
- Easy to set up, interpret the results, and monitor locally and through a cloud-based system
- Report and send alarms on user-specified levels locally via outputs to lights and relays, or via emails and text messages
- Information can be sent to the cloud by connecting to the local area network (LAN) with an Ethernet cable directly to the DXMR90 Industrial Controller
- Data can also be sent directly to a PLC or SCADA via Modbus TCP, EtherNet/IP, and PROFINET



More Sensors, More Solutions.

Banner Engineering designs and manufactures industrial automation products including sensors, smart IIoT and industrial wireless technologies, LED lights and indicators, measurement devices, machine safety equipment, as well as barcode scanners and machine vision. These solutions help make many of the things we use every day, from food and medicine to cars and electronics. A high-quality, reliable Banner product is installed somewhere around the world every two seconds. Headquartered in Minneapolis since 1966, Banner is an industry leader with more than 10,000 products, operations on five continents, and a world-wide team of more than 5,500 employees and partners. Our dedication to innovation and personable service makes Banner a trusted source of smart automation technologies to customers around the globe.

